

ACCUD

ACCURATE MEASUREMENT

CATALOGUE 2023



See full product range at: accud.com.au

CALIPERS



Dual Scale Vernier Caliper

Product No	Range	Graduation	Accuracy
AC-120-006-12	0-150 mm/0-6"	0.02 mm/0.001"	±0.03/01"
AC-120-008-12	0-200 mm/0-8"	0.02 mm/0.001"	±0.03/01"
AC-120-012-12	0-300 mm/0-12"	0.02 mm/0.001"	±0.04/02"



Metric Dial Caliper

Product No	Range	Graduation	Accuracy
AC-101-006-11	0-150 mm	0.02 mm	±0.03 mm
AC-101-008-11	0-200 mm	0.02 mm	±0.03 mm
AC-101-012-11	0-300 mm	0.02 mm	±0.04 mm



Coolant Proof IP67 Dual Scale Digital Caliper

Product No	Range	Resolution	Accuracy
AC-112-006-12	0-150 mm/0-6"	0.01 mm/005"	±0.03 mm/01"
AC-112-008-12	0-200 mm/0-8"	0.01 mm/005"	±0.03 mm/01"
AC-112-012-12	0-300 mm/0-12"	0.01 mm/005"	±0.03 mm/01"

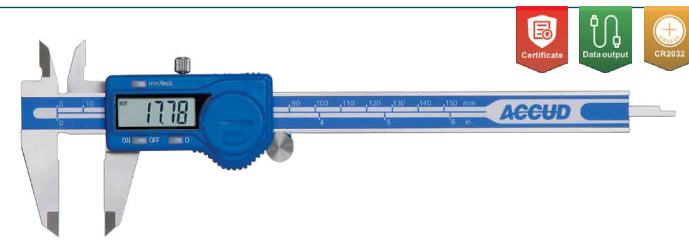

Dual Scale Digital Caliper

Product No	Range	Resolution	Accuracy
AC-111-006-12	0-150 mm/0-6"	0.01 mm	±0.03 mm
AC-111-008-12	0-200 mm/0-8"	0.01 mm	±0.03 mm
AC-111-012-12	0-300 mm/0-12"	0.01 mm	±0.03 mm



Splash Proof IP54 Dual Scale Digital Caliper

Product No	Range	Resolution	Accuracy
AC-111-006-11	0-150 mm/0-6"	0.01 mm/005"	±0.03 mm/01"
AC-111-008-11	0-200 mm/0-8"	0.01 mm/005"	±0.03 mm/01"
AC-111-012-11	0-300 mm/0-12"	0.01 mm/005"	±0.03 mm/01"

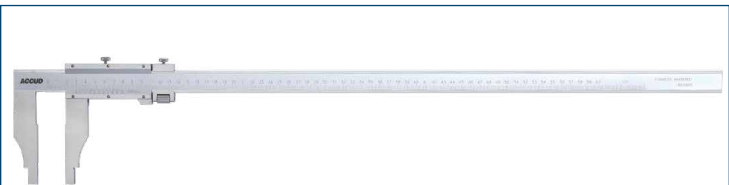

Dual Scale Vernier Caliper

Product No	Range	Graduation	Accuracy
AC-127-024-11	0-600 mm/0-24"	0.02 mm/01"	±0.05 mm
AC-127-040-11	0-1000 mm/0-40"	0.02 mm/01"	±0.08 mm
AC-127-080-11	0-2000 mm/0-80"	0.02 mm/01"	±0.14 mm

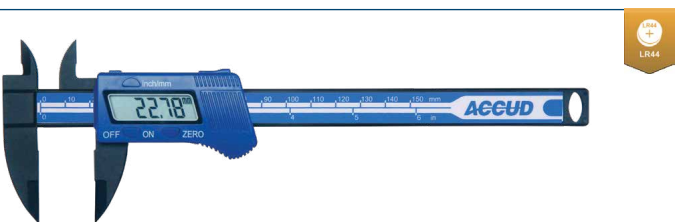

Digital Plastic Caliper

Product No	Range	Resolution	Accuracy
AC-117-006-11	0-150 mm/0-6"	0.01 mm/005"	±0.1 mm



IP54 Fractional Digital Caliper

Product No	Range	Resolution	Accuracy
AC-113-006-11	0-150 mm/0-6"	0.01 mm, 05", 1/128"	±0.03 mm
AC-113-008-11	0-200 mm/0-8"	0.01 mm, 05", 1/128"	±0.03 mm
AC-113-012-11	0-300 mm/0-12"	0.01 mm, 05", 1/128"	±0.03 mm

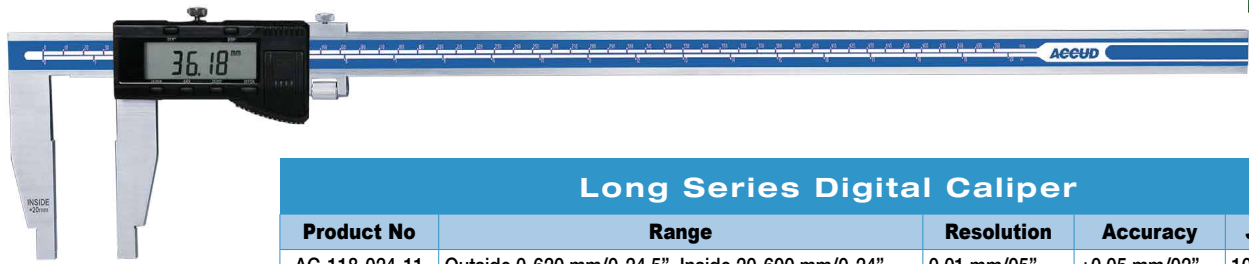

Long Series Digital Caliper

Product No	Range	Resolution	Accuracy	Jaw Reach
AC-118-024-11	Outside 0-620 mm/0-24.5", Inside 20-600 mm/0-24"	0.01 mm/05"	±0.05 mm/02"	100 mm
AC-118-040-11	Outside 0-1020 mm/0-40.2", Inside 20-1000 mm/0-40"	0.01 mm/05"	±0.08 mm/03"	150 mm



Caliper Point Extension Kit

Product No	Description	Max Jaw Thickness	Probe Length
GCAK	Measure slotted, stepped or grooved surfaces in hard to access spaces with four different point configurations.	4 mm	20 mm

INDICATORS

Dial Indicators



- Jeweled Bearing
- Limit hands
- Lug back

Product No	Description	Graduations	Accuracy
AC-222-010-11	10 mm Jeweled Bearing Dial Indicator	0.01 mm	20 µm
AC-229-025-11	25 mm Dial Indicator	0.01 mm	20 µm
AC-225-025-11	1" Dial Indicator	1"	20 µm

Dial Indicators

Product No	Range	Graduations	Accuracy
AC-229-030-11	30 mm	0.01 mm	±35 µm
AC-229-050-21	50 mm	0.01 mm	±35 µm
AC-225-050-11	2" Imperial	0.01 mm	±35 µm

- 1mm range revolution
- Lug and flat back



- Blowmould Case Included

Dial Indicators & Magnetic Stand Kits

Product No	AC-280-000-02	AC-280-001-02
Range	10 mm	1" Inch
Stem Hole	Ø4, Ø8, 3/8"	Ø4, Ø8, 3/8"
Magnetic Force	60 kgf	60 kgf
Graduations	0.01 mm	0.001"
Accuracy	±20 µm	±20 µm



25 mm Dual Scale Digital Indicator

Product No	AC-212-025-13
Range	25 mm
Resolution	0.01 mm / 005"
Accuracy	20 µm



Metric Indicator Point Extensions

Product No	Thread	Length
AC-270-000-04	M 2.5 x 0.45 mm	25 mm
AC-270-000-09	M 2.5 x 0.45 mm	50 mm
AC-270-000-14	M 2.5 x 0.45 mm	75 mm
AC-270-000-17	M 2.5 x 0.45 mm	100 mm



Imperial Indicator Point Extensions

Product No	Thread	Length
AC-270-000-011	0.112"x48 TPI	1"
AC-270-000-021	0.112"x48 TPI	2"
AC-270-000-031	0.112"x48 TPI	3"
AC-270-000-041	0.112"x48 TPI	4"



Fine Adjustment Magnetic Stand

Product No	AC-281-060-01
Stem Hole	8 mm
Magnetic Force	60 kgf

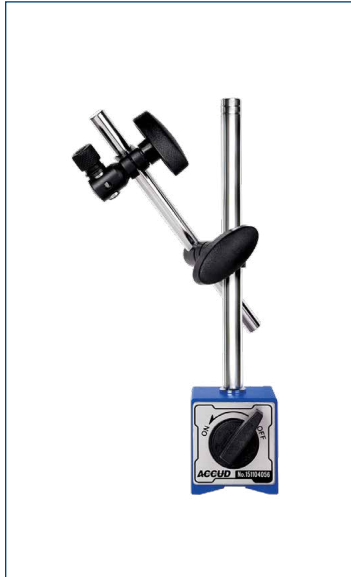

Magnetic Stand

Product No	AC-281-060-02
Stem Hole	8 mm
Magnetic Force	60 kgf



Mini Universal Magnetic Stand

Product No.	AC-286-040-01
Stem Hole	8 mm
Magnetic Force	40kgf
Height	231 mm
Arm Length	192 mm



Universal Magnetic Stand

Product No	AC-282-080-02
Stem Hole	8 mm
Magnetic Force	80kgf
Height	395 mm
Arm Length	340 mm

- For quick and accurate centering in boring and milling set-up
- Jeweled bearing
- Supplied with 7 feelers



Centering Indicator

Product No	AC-297-003-11
Range	0-3 mm
Graduation	0.01 mm
Size	150 x 60 x 33 mm

Indicator Centering Mount

Product No	AC-269-060-01
-------------------	---------------



TEST INDICATORS & BORE GAUGES



Dial Test Indicator

Product No	AC-261-008-11
Range	0.8 mm
Graduation	0.01 mm
Accuracy	±13 μm



Dial Bore Gauges

Product No	Range	Graduations	Accuracy
AC-251-035-11	18-35 mm	0.01 mm	±0.015 mm
AC-251-060-11	35-60 mm	0.01 mm	±0.018 mm
AC-251-160-11	50-160 mm	0.01 mm	±0.018 mm
AC-252-060-11	2-6"	0.01 mm	±0.0009"



18-160 mm Dial Bore Gauges Set

Product No	AC-251-346-13
Range	18-160 mm
Indicating Range	10 mm
Graduations	0.01 mm
Accuracy	18-35 mm / ±0.015 mm 35-60 mm / ±0.018 mm 50-160 mm / ±0.018 mm

PROTRACTORS & COMBINATION SQUARES



PN: AC-817-090-12

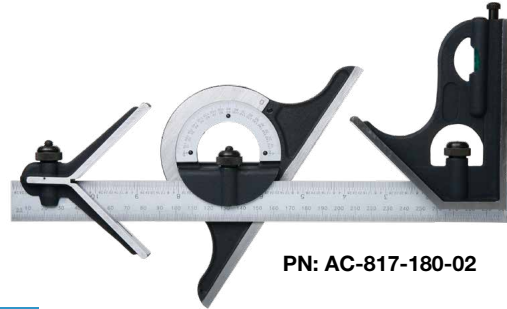

PN: AC-817-180-02

Combination Square Set

Product No	Circular Centre Finder	Protractor	90° or 45° Square
AC-817-090-12	N/A	N/A	90° square accuracy: $\pm 8'$ 45° square accuracy: $\pm 10'$
AC-817-180-02	Accuracy: ± 0.15 mm Ruler Range: 300 mm/12"	Range: 0-180° Accuracy: $\pm 7'$	90° square accuracy: $\pm 8'$ 45° square accuracy: $\pm 10'$

180° Angle Finder

Product No	Length	Graduations	Accuracy
AC-812-005-01	150 mm	1°	$\pm 0.3^\circ$
AC-812-006-01	200 mm	1°	$\pm 0.3^\circ$
AC-812-008-01	300 mm	1°	$\pm 0.3^\circ$
AC-812-012-01	500 mm	1°	$\pm 0.3^\circ$



Combination Digital Rulers

Product No	AC-821-008-01	AC-821-012-01
Length	200 mm	300 mm
Range	360°	360°
Resolution	0.1°	0.1°

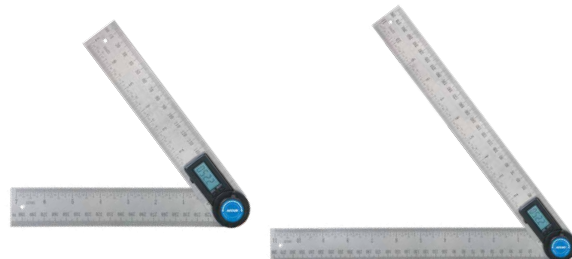

- Two vee & two flat reference faces



200 mm Frame Level

Product No	AC-711-008-02
Sensibility	0.02 mm/M per division
Size	200 x 200 x 42 mm

- Magnetic base, with V-groove



Digital Level & Protractor

Product No	AC-722-360-01
Size	150 x 60 x 33 mm
Accuracy	$\pm 0.1^\circ$ (at 0°/90°/180°/270°) $\pm 0.2^\circ$ (other direction)
Resolution	0.05°

- Magnetic Base



Digital Level

Product No	AC-721-180-01
Range	0-360°
Resolution	0.1°
Dimensions	59 x 59 x 28 mm
Accuracy	$\pm 0.1^\circ$ (vertical and horizontal) $\pm 0.2^\circ$ (other directions)

- Zero point, ABS, Hold
- Level Vial



Digital Protractor

Product No	AC-726-360-01
Range	360°
Resolution	0.05°
Accuracy	±0.15°
Length	250 mm

- 140° Vee Groove



Block Levels

Product No	AC-713-006-02	AC-713-008-02	AC-713-012-02
Sensibility	0.02 mm / M per division	0.02 mm / M per division	0.02 mm / M per division
Size	150 x 40 x 45 mm	200 x 42 x 47 mm	300 x 40 x 45 mm

600 mm Digital Level

Product No	AC-725-360-01
Units	Degree, Slope %, mm/M & In/Ft Pitch
Resolution	0.1°



- Function as level or protractor
- Back-light Display
- Absolute horizon memory
- Magnetic base

GAUGES



Telescopic Gauge Set

Product No	AC-951-006-01
Handle Lengths	115-137 mm
Gauge Sizes	8-12.7 mm, 12.7-19 mm, 19-32 mm, 32-54 mm, 54-90 mm & 90-150 mm



Small Hole Gauge Set

Product No	Ranges
AC-952-004-01	3-5 mm, 5-7.5 mm, 7.5-10 mm & 10-13 mm



Radius Gauge Set

Product No	AC-942-013-26
Range	0.5-13 mm
Accuracy	±0.05 mm
Increments	0.05 mm

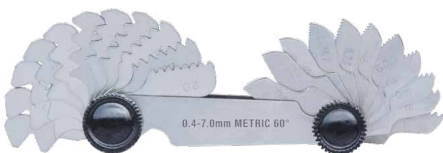

Thread Gauges Sets

Product No	Description	Range
AC-922-006-24	Metric Thread Gauge	0.25 - 6.0 mm
AC-924-042-30	Whitworth Thread Gauge	4-42 TPI
AC-925-062-52	Metric & Whitworth Thread Gauge	0.25 - 6.0 mm / 4-42 TPI

Circumference Tape		
Product No	Range	Graduations
AC-956-012-11	Dia. 20-300 mm / Cir. 60-950 mm	0.1 mm
AC-956-028-11	Dia. 300-700 mm / Cir. 940-2200 mm	0.1 mm
AC-956-044-11	Dia. 700-1100 mm / Cir. 2190-3460 mm	0.1 mm



20 Leaf Feeler Gauges Sets

Product No	Range	Length
AC-913-100-20	0.05 - 1 mm	150 mm
AC-914-100-20	0.05 - 1 mm	200 mm
AC-915-100-20	0.05 - 1 mm	300 mm



0.02 mm Feeler Tape

Product No	Size	Range	Accuracy
AC-916-002-01	13 mm x 5 m	0.02 mm	±4 μm
AC-916-004-01	13 mm x 5 m	0.04 mm	±4 μm



Fillet Weld Gauge

Product No	Sizes	Accuracy
AC-977-025-01	3, 4, 5, 6, 8, 9, 10, 11, 12, 14, 16, 19, 22, 25 mm	0.5 mm

Welding Gauge				
Product No		Range	Graduation	Accuracy
AC-978-006-01	Undercut Depth	0 - 6mm	0.5mm	0.5mm
	Crown Height	0 - 6mm	0.5mm	0.5mm
	Porosity Size Comparison	1.5mm, 3mm	—	—
	Amount of Porosity / 25mm	25mm	1mm	0.5mm



RULERS

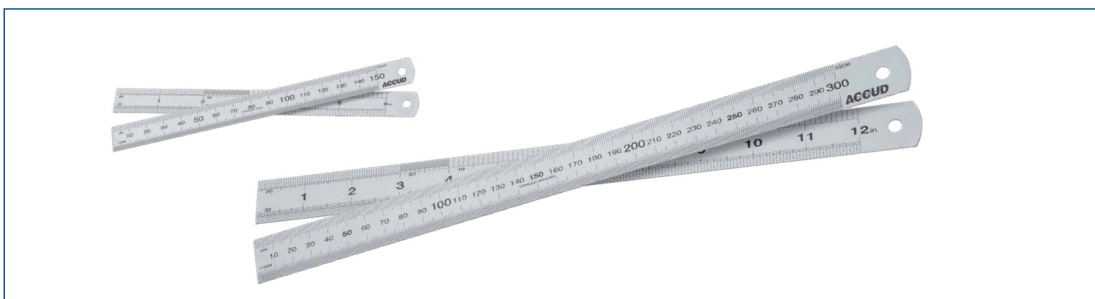

Dual Scale Stainless Rulers

Product No	Range
AC-990-006-11	150 mm / 6"
AC-990-012-11	300 mm / 12"
AC-990-024-11	600 mm / 24"
AC-990-040-11	1000 mm / 40"



Straight Edge Rulers

Product No	Graduations	Beam Width	Length
AC-991-012-01	1 mm	40 mm	300 mm
AC-991-020-01	1 mm	40 mm	500 mm
AC-991-040-01	1 mm	50 mm	1000 mm

MEASURING TOOL SETS & ACCESSORIES



3 Piece Measuring Tool Set

Product No	Specifications
AC-280-000-13	150mm Digital Caliper Resolution: 0.01 mm / 0.0005" Accuracy: ±0.03 mm
	25mm Outside Micrometer Graduation: 0.01 mm Accuracy: 4 µm
	Beveled Square Size: 100 x 70 mm DIN875 grade 0 Squareness: 7 µm



Micrometer Stand

Product No	AC-381-000-00
------------	---------------

- For all capilers with 16 mm beam
- Made of stainless steel



Caliper Base Attachments

Product No	Range
AC-179-000-00	75 mm
AC-179-000-01	100 mm

OUTSIDE MICROMETERS

- Carbide measuring faces
- Setting standard included
- Ratchet stop



Sizes available up to 1000 mm

Imperial sizes available

Metric Outside Micrometers

Product No	Range	Graduation	Accuracy	Jaw Reach
AC-321-001-01	25 mm	0.01 mm	4 µm	29 mm
AC-321-002-01	25-50 mm	0.01 mm	4 µm	39 mm
AC-321-003-01	50-75 mm	0.01 mm	5 µm	53 mm

- Functions: mm/ inch, Origin, zero point, ABS, Hold
- IP65 protection level
- Carbide measuring faces
- Ratchet stop



Coolant Proof IP65 Dual Scale Digital Micrometers

Product No	Range	Graduation	Accuracy	Jaw Reach
AC-313-001-02	25 mm	01 mm	3 µm	25 mm
AC-313-002-02	25-50 mm	01 mm	3 µm	32 mm



Micrometer Sets

Product No	Description	Range	Graduation	Accuracy
AC-321-003-03	Sets of 3 Micrometers	0-75 mm	0.01 mm	5 µm
AC-321-004-04	Sets of 4 Micrometers	0-400 mm	0.01 mm	±4-5 µm
AC-321-006-06	Sets of 6 Micrometers	0-150 mm	0.01 mm	±4-6 µm
AC-321-012-06	Sets of 6 Micrometers	150-300 mm	0.01 mm	7-9 µm
AC-321-012-12	Sets of 12 Micrometers	0-300 mm	0.01 mm	5-9 µm

Imperial sets available

INSIDE MICROMETERS

• Carbide measuring faces



Tubular Inside Micrometer Sets

Product No	Range	Head Range	Graduation
AC-352-012-01	50-300 mm	13 mm	13 mm
AC-352-024-01	50-600 mm	0.01 mm	0.01MM

MACHINIST SQUARES



Wide Base Machinist Squares (Grade 2)

Product No	Size	Blade Thickness
AC-845-004-02	100H x 70W x 12T mm	3 mm
AC-845-006-02	150H x 100W x 16T mm	3 mm
AC-845-008-02	200H x 130W x 16T mm	4 mm
AC-845-012-02	300H x 200W x 19T mm	4 mm
AC-845-024-02	600H x 350W x 30T mm	6 mm

SPRING CALIPERS



Inside Spring Calipers

Product No	Range	Length
AC-982-008-01	18-190 mm	200 mm
AC-982-012-01	18-290 mm	300 mm
AC-982-020-01	25-490 mm	500 mm



Spring Dividers

Product No	Range	Length
AC-985-008-01	0-190 mm	200 mm
AC-985-012-01	0-290 mm	300 mm
AC-985-020-01	0-490 mm	500 mm



Outside Spring Caliper

Product No	Range	Length
AC-984-008-01	0-190 mm	200 mm
AC-984-012-01	0-290 mm	300 mm
AC-984-020-01	0-490 mm	500 mm



Double Ended Scribe

Product No	Length	Description
AC-995-009-01	250 mm	Nickel plated with Hardened tips Knurled handle

DEPTH GAUGES

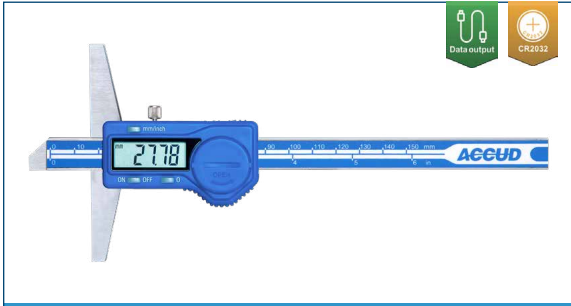

Digital Depth Calipers

Product No	Range	Resolution	Accuracy
AC-171-008-11	200 mm	0.01 mm	±0.03 mm
AC-171-012-11	300 mm	0.01 mm	±0.03 mm
AC-171-020-11	500 mm	0.01 mm	±0.03 mm



25 mm Digital Depth Caliper

Product No	AC-176-001-11
Resolution	0.01 mm
Accuracy	±0.03



Micrometer with Captive Anvils

Product No	Range	Accuracy	Base size
AC-392-006-01	0-150 mm	±3 μm	101.5 x 17 mm
AC-392-012-01	0-300 mm	±3 μm	101.5 x 17 mm

HEIGHT GAUGES



Dual Scale Digital Height Gauge

Product No	AC-181-012-11	AC-181-024-11	AC-181-040-11
Range	0-300mm/0-12"	0-600mm/0-24"	0-1000mm/0-40"
Accuracy	±0.04 mm	±0.05 mm	±0.07 mm
Resolution	0.01 mm/0.0005"	0.01 mm/0.0005"	0.01 mm/0.0005"

Dual Scale Digital Height Gauge

Product No	AC-182-012-11	AC-182-024-11	AC-182-040-11
Range	0-300 mm/0-12"	0-600 mm/0-24"	0-1000 mm/0-40"
Accuracy	±0.04 mm	±0.05 mm	±0.05 mm
Resolution	0.01 mm/0.001"	0.01 mm/0.001"	0.01 mm/0.001"



DIGITAL MEASURING

- Fast & Slow display functions, Continuous & Min/Max functions
- Programmable Exceedance Alarm
- Back-lit LCD

Digital Sound Level Meter

Product No	AC-SLM130
Measuring Range	30-130db
Accuracy	1.5dB
Resolution	0.1dB
Weight	64g



- Temperature & Wind Speed display
- Real-time/Max/Average functions
- Unit: m/s, km/h, ft/min, Knots, mph
- Back-lit LCD

Digital Anemometer

Product No	AC-AM30
Measuring Range	0.3-30 m/s
Accuracy	±5%
Resolution	0.1 m/s
Weight	154g



Portable Hardness Tester



Product No	Specifications
AC-HL350	Resolution: 1 HLD, 1 HV, 1 HB, 0.1 HRC, 0.1 HRB, 1 HS, 1 MPa Units: HV, HB, HRC, HRB, HS & tensile strength MPa Accuracy: $\pm 8\text{HLD}/0.8\text{HRC}(\text{HLD}=800)$ Min. Sample weight: >5kg (directly) >2kg (on solid support) >0.1kg (coupled to solid support) Min. Sample thickness: >5 mm Min. Sample diameter: >22 mm Max. Sample surface roughness: Ra<1.6 μm Power Supply: 3xAAA batteries Included: Test block, Small support ring, Brush & USB cable.



Moisture Meter

Product No	AC-WMM700
Temp. Range	-10°C-60°C
Humidity Range	0.1%RH
Moisture Range	2-40 / 50 / 60 / 70% (for different wood samples)



Laser Tachometer

Product No.	AC-LT900
Sampling Range	50-500 mm
Range	2.5-99999 rpm
Power Supply	2 x AAA battery
Weight	106g

- Capture pictures or record video
- 8 LED Light array
- Measuring software and calibration rule included



200x Wifi Digital Microscope

Product No.	AC-WIFI200
Resolution	2 Megapixel
Magnification	10x - 200x
Interface	USB2.0 or WiFi

- IP54 protection level
- Laser Sight
- Built-in Spirit Level
- Back-light LCD Display
- Battery Power Indicator
- 1/4"-20 UNC Tripod Mount

100 Metre Laser Distance Meter

Product No	AC-TM100
Measuring Range	0.1-100 m
Accuracy	1.5 mm
Units	Metre / Inch / Foot
Light Spot	8 mm @ 40 m
Power Supply	2 x 1.5V AAA
Weight	110 g



- Adjustable Emission Compensation
- Back-light LCD Display
- High & Low Temp. Alarm
- 100 Sample Point Memory
- Mutable sample capture alarm
- Battery Power Indicator
- 1/4"-20 UNC Tripod Mount
- Laser Sight

Infrared Thermometer

Product No	AC-IT700
Measuring Range	-50°C to 950°C
Accuracy	1.5% or 1.5°C
Distance spot ratio	12:1



ACCUD



accud.com.au

Distributed by:



M Gamer Pty Ltd is an authorized distributor for Accud products in Australia.